



# 4-Wire-Interfaced, 2.5V to 5.5V, 20-Port and 28-Port LED Display Driver and I/O Expander

MAX6957

## General Description

The MAX6957 compact, serial-interfaced LED display driver general-purpose I/O (GPIO) peripheral provides microprocessors with up to 28 ports. Each port is individually user configurable to either a logic input, logic output, or common-anode (CA) LED constant-current segment driver. Each port configured as an LED segment driver behaves as a digitally controlled constant-current sink, with 16 equal current steps from 1.5mA to 24mA. The LED drivers are suitable for both discrete LEDs and CA numeric and alphanumeric LED digits.

Each port configured as a GPIO can be either a push-pull logic output capable of sinking 10mA and sourcing 4.5mA, or a Schmitt logic input with optional internal pullup. Seven ports feature configurable transition detection logic, which generates an interrupt upon change of port logic level. The MAX6957 is controlled through an SPI™-compatible 4-wire serial interface.

The MAX6957AAX and MAX6957ATL have 28 ports and are available in 36-pin SSOP and 40-pin QFN packages, respectively. The MAX6957AAI and MAX6957ANI have 20 ports and are available in 28-pin SSOP and 28-pin DIP packages, respectively.

For a 2-wire interfaced version, refer to the MAX6956 data sheet.

For a lower cost pin-compatible port expander without the constant-current LED drive capability, refer to the MAX7301 data sheet.

## Applications

- Set-Top Boxes
- Panel Meters
- White Goods
- Automotive
- Bar Graph Displays
- Industrial Controllers
- System Monitoring

**Typical Operating Circuit appears at end of data sheet.**

*SPI and QSPI are trademarks of Motorola, Inc.*

*MICROWIRE is a trademark of National Semiconductor Corp.*

## Features

- ◆ High-Speed 26MHz SPI-/QSPI™-/MICROWIRE™-Compatible Serial Interface
- ◆ 2.5V to 5.5V Operation
- ◆ -40°C to +125°C Temperature Range
- ◆ 20 or 28 I/O Ports, Each Configurable as
  - Constant-Current LED Driver
  - Push-Pull Logic Output
  - Schmitt Logic Input
  - Schmitt Logic Input with Internal Pullup
- ◆ 11µA (max) Shutdown Current
- ◆ 16-Step Individually Programmable Current Control for Each LED
- ◆ Logic Transition Detection for Seven I/O Ports

## Ordering Information

PART	TEMP RANGE	PIN-PACKAGE
MAX6957ANI	-40°C to +125°C	28 DIP
MAX6957AAI	-40°C to +125°C	28 SSOP
MAX6957AAX	-40°C to +125°C	36 SSOP
MAX6957ATL	-40°C to +125°C	40 Thin QFN

## Pin Configurations

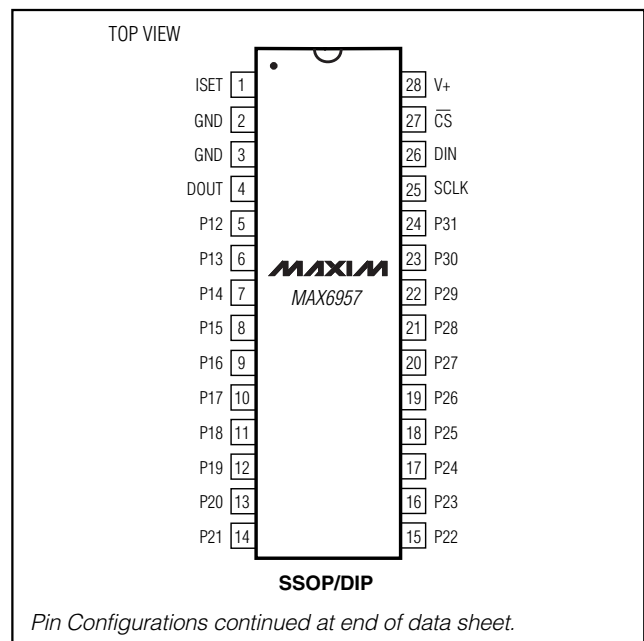

# 4-Wire-Interfaced, 2.5V to 5.5V, 20-Port and 28-Port LED Display Driver and I/O Expander

## ABSOLUTE MAXIMUM RATINGS

Voltage (with Respect to GND)	
V+ .....	-0.3V to +6V
All Other pins .....	-0.3V to (V+ + 0.3V)
P4–P31 Current .....	±30mA
GND Current .....	800mA
Continuous Power Dissipation (T <sub>A</sub> = +70°C)	
28-Pin PDIP (derate 20.8mW/°C above +70°C) .....	1667mW
28-Pin SSOP (derate 9.5mW/°C above +70°C) .....	762mW
36-Pin SSOP (derate 11.8mW/°C above +70°C) .....	941mW

Operating Temperature Range (T <sub>MIN</sub> , T <sub>MAX</sub> ) .....	-40°C to +125°C
Junction Temperature .....	+150°C
Storage Temperature Range .....	-65°C to +150°C
Lead Temperature (soldering, 10s) .....	+300°C

Stresses beyond those listed under "Absolute Maximum Ratings" may cause permanent damage to the device. These are stress ratings only, and functional operation of the device at these or any other conditions beyond those indicated in the operational sections of the specifications is not implied. Exposure to absolute maximum rating conditions for extended periods may affect device reliability.

## ELECTRICAL CHARACTERISTICS

(Typical Operating Circuit, V+ = 2.5V to 5.5V, T<sub>A</sub> = T<sub>MIN</sub> to T<sub>MAX</sub>, unless otherwise noted.) (Note 1)

PARAMETER	SYMBOL	CONDITIONS	MIN	TYP	MAX	UNITS
Operating Supply Voltage	V+		2.5		5.5	V
Shutdown Supply Current	ISHDN	All digital inputs at V+ or GND	T <sub>A</sub> = +25°C	5.5	8	μA
			T <sub>A</sub> = -40°C to +85°C		10	
			T <sub>A</sub> = T <sub>MIN</sub> to T <sub>MAX</sub>		11	
Operating Supply Current	IGPOH	All ports programmed as outputs high, no load, all other inputs at V+ or GND	T <sub>A</sub> = +25°C	180	230	μA
			T <sub>A</sub> = -40°C to +85°C		250	
			T <sub>A</sub> = T <sub>MIN</sub> to T <sub>MAX</sub>		270	
Operating Supply Current	IGPOL	All ports programmed as outputs low, no load, all other inputs at V+ or GND	T <sub>A</sub> = +25°C	170	210	μA
			T <sub>A</sub> = -40°C to +85°C		230	
			T <sub>A</sub> = T <sub>MIN</sub> to T <sub>MAX</sub>		240	
Operating Supply Current	ILED	All ports programmed as LED outputs, all LEDs off, no load, all other inputs at V+ or GND	T <sub>A</sub> = +25°C	110	135	μA
			T <sub>A</sub> = -40°C to +85°C		140	
			T <sub>A</sub> = T <sub>MIN</sub> to T <sub>MAX</sub>		145	
<b>INPUTS AND OUTPUTS</b>						
Logic-High Input Voltage Port Inputs	V <sub>IH</sub>		0.7 × V+			V
Logic-Low Input Voltage Port Inputs	V <sub>IL</sub>				0.3 × V+	V
Input Leakage Current	I <sub>IH</sub> , I <sub>IL</sub>	GPIO inputs without pullup, V <sub>PORT</sub> = V+ to GND	-100	±1	+100	nA
GPIO Input Internal Pullup to V+	I <sub>PU</sub>	V+ = 2.5V	12	19	30	μA
		V+ = 5.5V	80	120	180	
Hysteresis Voltage GPIO Inputs	ΔV <sub>I</sub>			0.3		V
Output High Voltage	V <sub>OH</sub>	GPIO outputs, I <sub>SOURCE</sub> = 2mA, T <sub>A</sub> = -40°C to +85°C	V+ -			V
			0.7			
Output High Voltage	V <sub>OH</sub>	GPIO outputs, I <sub>SOURCE</sub> = 1mA, T <sub>A</sub> = T <sub>MIN</sub> to T <sub>MAX</sub> (Note 2)	V+ -			V
				0.7		

# 4-Wire-Interfaced, 2.5V to 5.5V, 20-Port and 28-Port LED Display Driver and I/O Expander

MAX6957

## ELECTRICAL CHARACTERISTICS (continued)

(Typical Operating Circuit,  $V_+ = 2.5V$  to  $5.5V$ ,  $T_A = T_{MIN}$  to  $T_{MAX}$ , unless otherwise noted.) (Note 1)

PARAMETER	SYMBOL	CONDITIONS	MIN	TYP	MAX	UNITS
Port Sink Current	$I_{OL}$	$V_{PORT} = 0.6V$	2	10	18	mA
Output Short-Circuit Current	$I_{OLSC}$	Port configured output low, shorted to $V_+$	2.75	11	20	mA
Port Drive LED Sink Current, Port Configured as LED Driver	$I_{PORT}$	$V_+ = 2.5V$ , $V_{LED} = 2.3V$ at maximum LED current	9.5	13.5	18	mA
		$V_+ = 3.3V$ , $V_{LED} = 2.4V$ at maximum LED current (Note 2)	18.5	24	27.5	
		$V_+ = 5.5V$ , $V_{LED} = 2.4V$ at maximum LED current	19	25	30	
Port Drive Logic Sink Current, Port Configured as LED Driver	$I_{PORT\_SC}$	$V_+ = 2.5V$ , $V_{OUT} = 0.6V$ at maximum LED current	18.5	23	28.0	mA
		$V_+ = 5.5V$ , $V_{OUT} = 0.6V$ at maximum LED current	19	24	28	
Port LED Sink Current Matching	$\Delta I_{PORT}$			6		%
Input High-Voltage SCLK, DIN, $\overline{CS}$	$V_{IH}$	$V_+ \leq 3.3V$	1.6			V
		$V_+ > 3.3V$	2			
Input Low-Voltage SCLK, DIN, $\overline{CS}$	$V_{IL}$				0.6	V
Input Leakage Current SCLK, DIN, $\overline{CS}$	$I_{IH}$ , $I_{IL}$		-50		+50	nA
Output High-Voltage DOUT	$V_{OH}$	$I_{SOURCE} = 1.6mA$	$V_+ - 0.5$			V
Output Low-Voltage DOUT	$V_{OL}$	$I_{SINK} = 1.6mA$			0.4	V

## TIMING CHARACTERISTICS (Figure 3)

( $V_+ = 2.5V$  to  $5.5V$ ,  $T_A = T_{MIN}$  to  $T_{MAX}$ , unless otherwise noted.) (Note 1)

PARAMETER	SYMBOL	CONDITIONS	MIN	TYP	MAX	UNITS
CLK Clock Period	$t_{CP}$		38.4			ns
CLK Pulse Width High	$t_{CH}$		19			ns
CLK Pulse Width Low	$t_{CL}$		19			ns
$\overline{CS}$ Fall to SCLK Rise Setup Time	$t_{CSS}$		9.5			ns
CLK Rise to $\overline{CS}$ Rise Hold Time	$t_{CSH}$		0			ns
DIN Setup Time	$t_{DS}$		9.5			ns
DIN Hold Time	$t_{DH}$		0			ns
Output Data Propagation Delay	$t_{DO}$	$C_{LOAD} = 25pF$			21	ns
Minimum $\overline{CS}$ Pulse High	$t_{CSW}$		19			ns

**Note 1:** All parameters tested at  $T_A = +25^\circ C$ . Specifications over temperature are guaranteed by design.

**Note 2:** Guaranteed by design.

# 4-Wire-Interfaced, 2.5V to 5.5V, 20-Port and 28-Port LED Display Driver and I/O Expander

## Typical Operating Characteristics

( $R_{ISET} = 39k\Omega$ ,  $T_A = +25^\circ C$ , unless otherwise noted.)

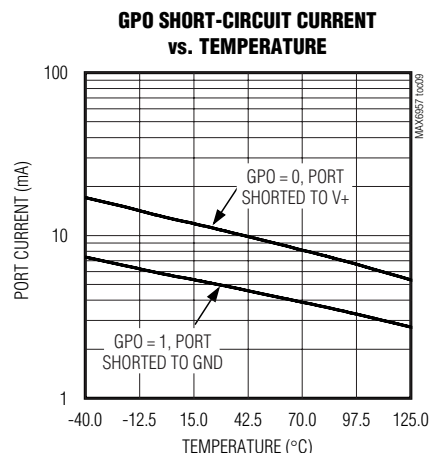
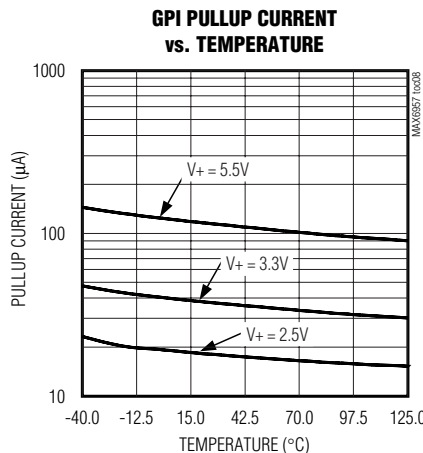
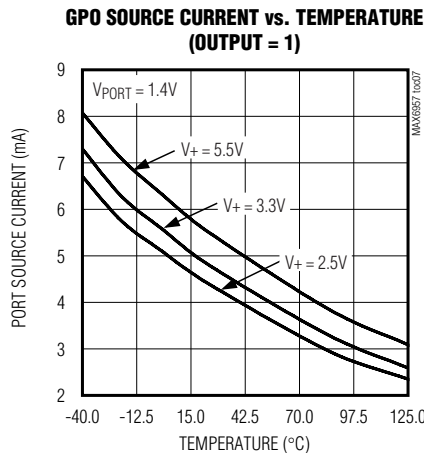
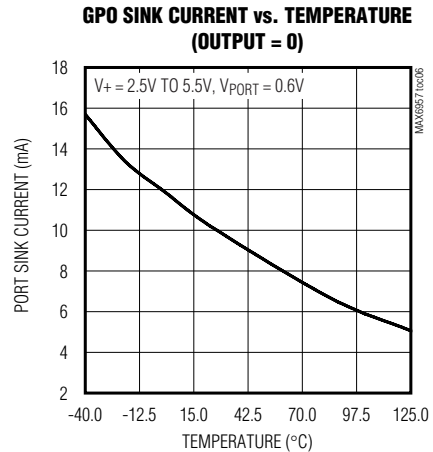
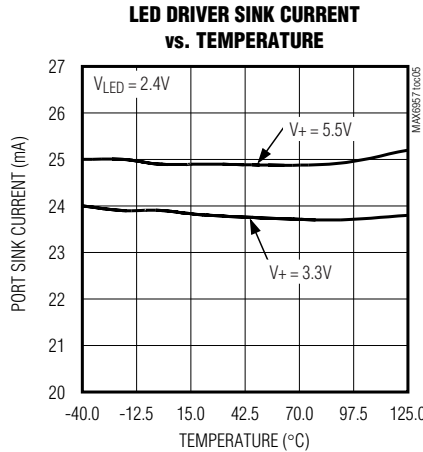
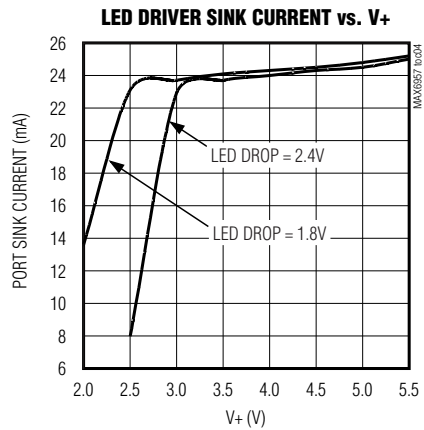
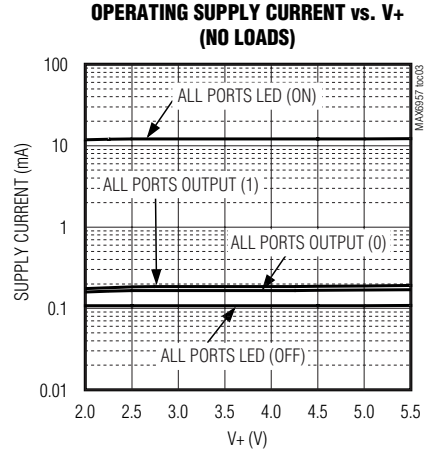
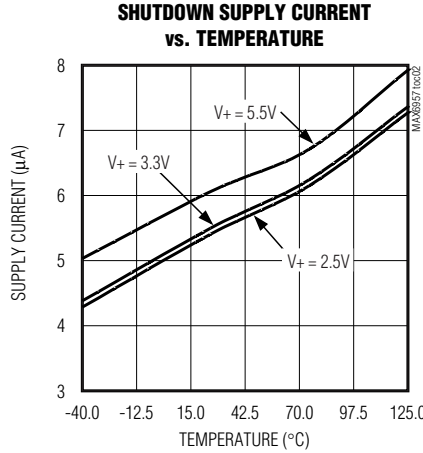
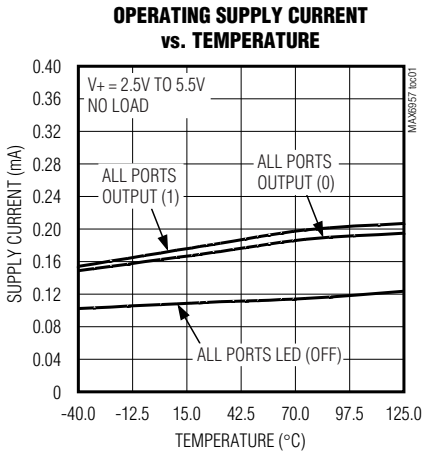

# 4-Wire-Interfaced, 2.5V to 5.5V, 20-Port and 28-Port LED Display Driver and I/O Expander

## Pin Description

MAX6957

PIN		NAME	FUNCTION
SSOP DIP	SSOP		
1	1	ISET	Segment Current Setting. Connect ISET to GND through a resistor (R <sub>ISET</sub> ) to set the maximum segment current.
2, 3	2, 3	GND	Ground
4	4	DOUT	4-Wire Serial Data Output Port
5–24	—	P12–P31	LED Segment Drivers and GPIO. P12 to P31 can be configured as CA LED drivers, GPIO outputs, CMOS logic inputs, or CMOS logic inputs with weak pullup resistor.
—	5–32	P4–P31	LED Segment Drivers and GPIO. P4 to P31 can be configured as CA LED drivers, GPIO outputs, CMOS logic inputs, or CMOS logic inputs with weak pullup resistor.
25	33	SCLK	4-Wire Serial Clock Input Port
26	34	DIN	4-Wire Serial Data Input Port
27	35	$\overline{\text{CS}}$	4-Wire Chip-Select Input, Active Low
28	36	V+	Positive Supply Voltage. Bypass V+ to GND with a minimum 0.047 $\mu$ F capacitor.

## Detailed Description

The MAX6957 LED driver/GPIO peripheral provides up to 28 I/O ports, P4 to P31, controlled through an SPI-compatible serial interface. The ports can be configured to any combination of constant-current LED drivers, logic inputs and logic outputs, and default to logic inputs on power-up. When fully configured as an LED driver, the MAX6957 controls up to 28 LED segments with individual 16-step adjustment of the constant current through each LED segment. A single resistor sets the maximum segment current for all segments, with a maximum of 24mA per segment. The MAX6957 drives any combination of discrete LEDs and CA digits, including seven-segment and starburst alphanumeric types.

Figure 1 is the MAX6957 functional diagram. Any I/O port can be configured as a push-pull output (sinking 10mA, sourcing 4.5mA), or a Schmitt-trigger logic input. Each input has an individually selectable internal pullup resistor. Additionally, transition detection allows seven ports (P24 through P30) to be monitored in any maskable combination for changes in their logic status. A detected transition is flagged through an interrupt pin (port P31).

The *Typical Operating Circuit* shows two MAX6957s working together controlling three monochrome 16-segment-plus-DP displays, with five ports left available for GPIO (P27–P31 of U2).

The port configuration registers set the 28 ports, P4 to P31, individually as either LED drivers or GPIO. A pair of bits in registers 0x09 through 0x0F sets each port's configuration (Tables 1 and 2).

The 36-pin MAX6957AAX has 28 ports, P4 to P31. The 28-pin MAX6957ANI and MAX6957AAI make only 20 ports available. The eight unused ports should be configured as outputs on power-up by writing 0x55 to registers 0x09 and 0x0A. If this is not done, the eight unused ports remain as floating inputs and quiescent supply current rises, although there is no damage to the part.

### Register Control of I/O Ports and LEDs Across Multiple Drivers

The MAX6957 offers 20 or 28 I/O ports, depending on package choice. These can be applied to a variety of combinations of different display types, for example: seven, 7-segment digits (Figure 2). This example requires two MAX6957s, with one digit being driven by both devices, half by one MAX6957, half by the other (digit 4 in this example). The two drivers are static, and therefore do not need to be synchronized. The MAX6957 sees CA digits as multiple discrete LEDs. To simplify access to displays that overlap two MAX6957s, the MAX6957 provides four virtual ports P0 through P3. To update an overlapping digit, send the same code twice as an eight-port write, once to P28 through P35 of the first driver, and again to P0 through P7 of the sec-

# 4-Wire-Interfaced, 2.5V to 5.5V, 20-Port and 28-Port LED Display Driver and I/O Expander

**Table 1. Port Configuration Map**

REGISTER	ADDRESS CODE (HEX)	REGISTER DATA							
		D7	D6	D5	D4	D3	D2	D1	D0
Port Configuration for P7, P6, P5, P4	0x09	P7		P6		P5		P4	
Port Configuration for P11, P10, P9, P8	0x0A	P11		P10		P9		P8	
Port Configuration for P15, P14, P13, P12	0x0B	P15		P14		P13		P12	
Port Configuration for P19, P18, P17, P16	0x0C	P19		P18		P17		P16	
Port Configuration for P23, P22, P21, P20	0x0D	P23		P22		P21		P20	
Port Configuration for P27, P26, P25, P24	0x0E	P27		P26		P25		P24	
Port Configuration for P31, P30, P29, P28	0x0F	P31		P30		P29		P28	

**Table 2. Port Configuration Matrix**

MODE	FUNCTION	PORT REGISTER (0x20–0x5F) (0xA0–0xDF)	PIN BEHAVIOR	ADDRESS CODE (HEX)	PORT CONFIGURATION BIT PAIR	
					UPPER	LOWER
Output	LED Segment Driver	Register bit = 0	High impedance	0x09 to 0x0F	0	0
		Register bit = 1	Open-drain current sink, with sink current (up to 24mA) determined by the appropriate current register			
Output	GPIO Output	Register bit = 0	Active-low logic output	0x09 to 0x0F	0	1
			Active-high logic output			
Input	GPIO Input Without Pullup	Register bit = input logic level	Schmitt logic input	0x09 to 0x0F	1	0
Input	GPIO Input with		Schmitt logic input with pullup	0x09 to 0x0F	1	1

**Note:** The logic is inverted between the two output modes; a high makes the output go low in LED segment driver mode (0x00) to turn that segment on; in GPIO output mode (0x01), a high makes the output go high.

ond driver. The first driver ignores the last 4 bits and the second driver ignores the first 4 bits.

Two addressing methods are available. Any single port (bit) can be written (set/cleared) at once; or, any sequence of eight ports can be written (set/cleared) in any combination at once. There are no boundaries; it is equally acceptable to write P0 through P7, P1 through P8, or P31 through P38 (P32 through P38 are nonexistent, so the instructions to these bits are ignored).

Using 8-bit control, a seven-segment digit with a decimal point can be updated in a single byte-write, a 14-segment digit with DP can be updated in two byte-writes, and 16-segment digits with DP can be updated in two byte-writes plus a bit write. Also, discrete LEDs and GPIO port bits can be lit and controlled individually without affecting other ports.

## Shutdown

When the MAX6957 is in shutdown mode, all ports are forced to inputs, and the pullup current sources are turned off. Data in the port and control registers remain unaltered so port configuration and output levels are restored when the MAX6957 is taken out of shutdown. The display driver can still be programmed while in shutdown mode. For minimum supply current in shutdown mode, logic inputs should be at GND or V+ potential. Shutdown mode is exited by setting the S bit in the configuration register (Table 6). Shutdown mode is temporarily overridden by the display test function.

# 4-Wire-Interfaced, 2.5V to 5.5V, 20-Port and 28-Port LED Display Driver and I/O Expander

MAX6957

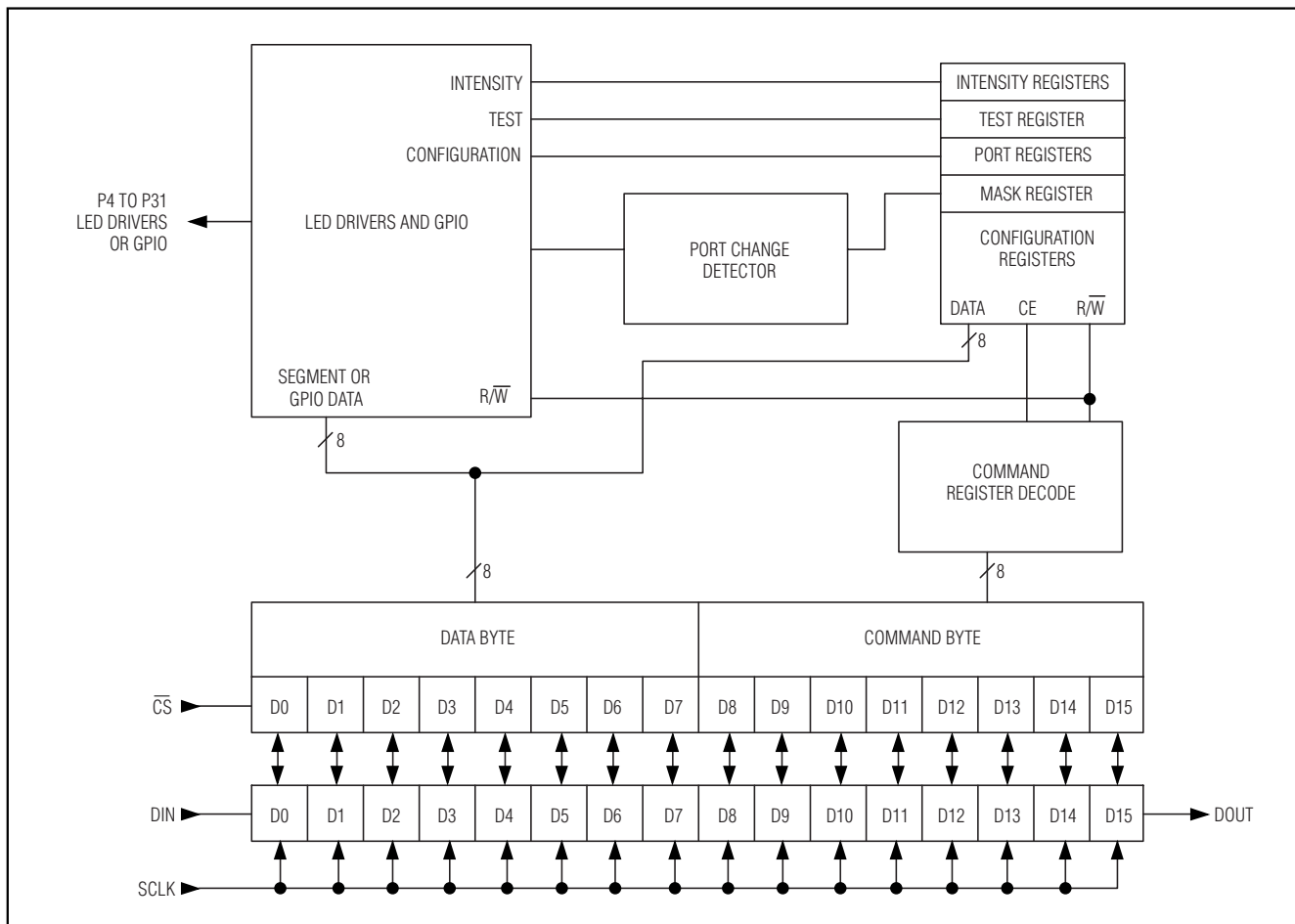

Figure 1. MAX6957 Functional Diagram

## Serial Interface

The MAX6957 communicates through an SPI-compatible 4-wire serial interface. The interface has three inputs, Clock (SCLK), Chip Select ( $\overline{CS}$ ), and Data In (DIN), and one output, Data Out (DOUT).  $\overline{CS}$  must be low to clock data into or out of the device, and DIN must be stable when sampled on the rising edge of SCLK. DOUT provides a copy of the bit that was input 15.5 clocks earlier, or upon a query it outputs internal register data, and is stable on the rising edge of SCLK. **Note that the SPI protocol expects DOUT to be high impedance when the MAX6957 is not being accessed; DOUT on the MAX6957 is never high impedance. Go to [www.maxim-ic.com/an1879](http://www.maxim-ic.com/an1879) for ways to convert DOUT to tri-state, if required.**

SCLK and DIN may be used to transmit data to other peripherals, so the MAX6957 ignores all activity on

SCLK and DIN except between the fall and subsequent rise of  $\overline{CS}$ .

## Control and Operation Using the 4-Wire Interface

Controlling the MAX6957 requires sending a 16-bit word. The first byte, D15 through D8, is the command address (Table 3), and the second byte, D7 through D0, is the data byte (Table 4).

### Connecting Multiple MAX6957s to the 4-Wire Bus

Multiple MAX6957s may be daisy-chained by connecting the DOUT of one device to the DIN of the next, and driving SCLK and  $\overline{CS}$  lines in parallel (Figure 4). Data at DIN propagates through the internal shift registers and appears at DOUT 15.5 clock cycles later, clocked out on the falling edge of SCLK. When sending commands to multiple MAX6957s, all devices are accessed at the

# 4-Wire-Interfaced, 2.5V to 5.5V, 20-Port and 28-Port LED Display Driver and I/O Expander

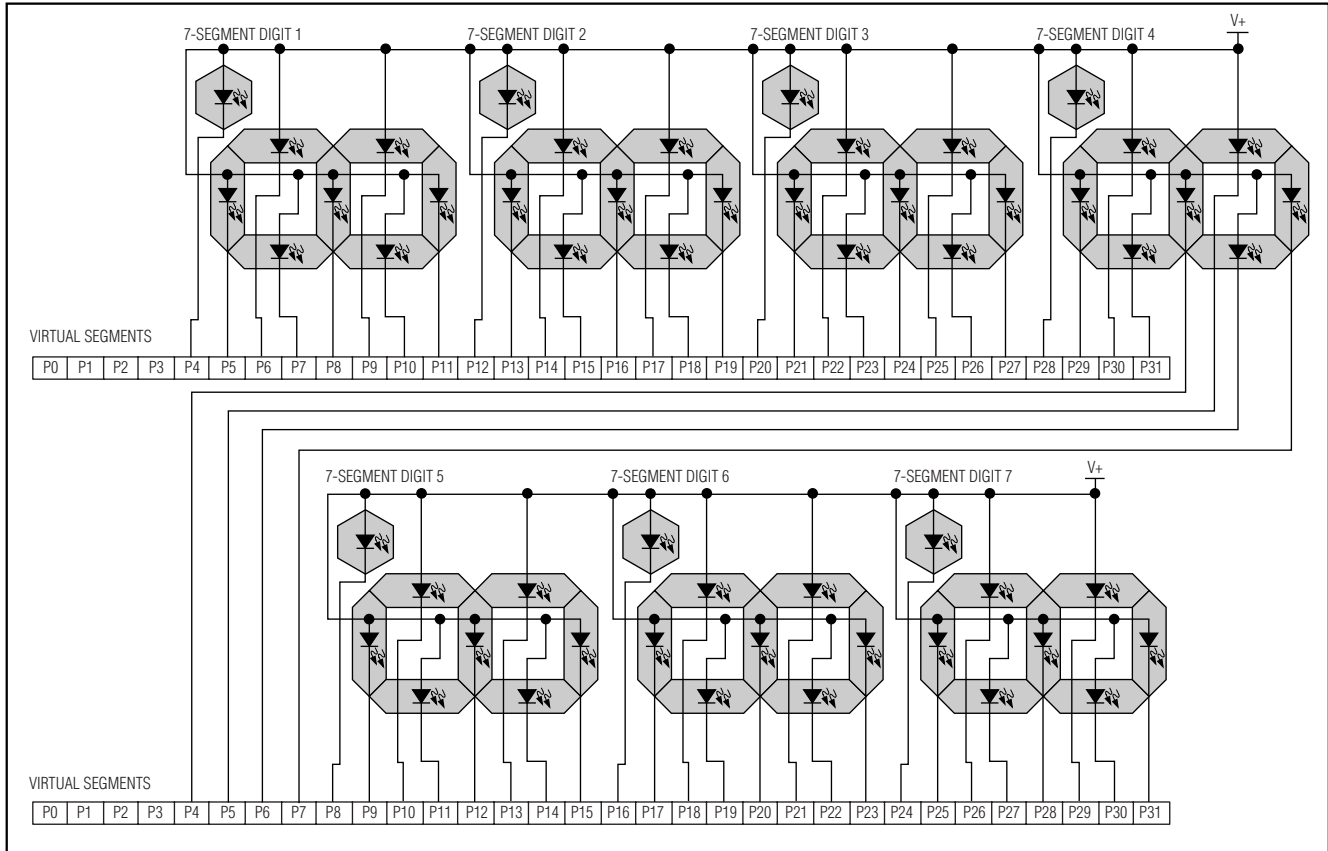

Figure 2. Two MAX6957s Controlling Seven 7-Segment Displays

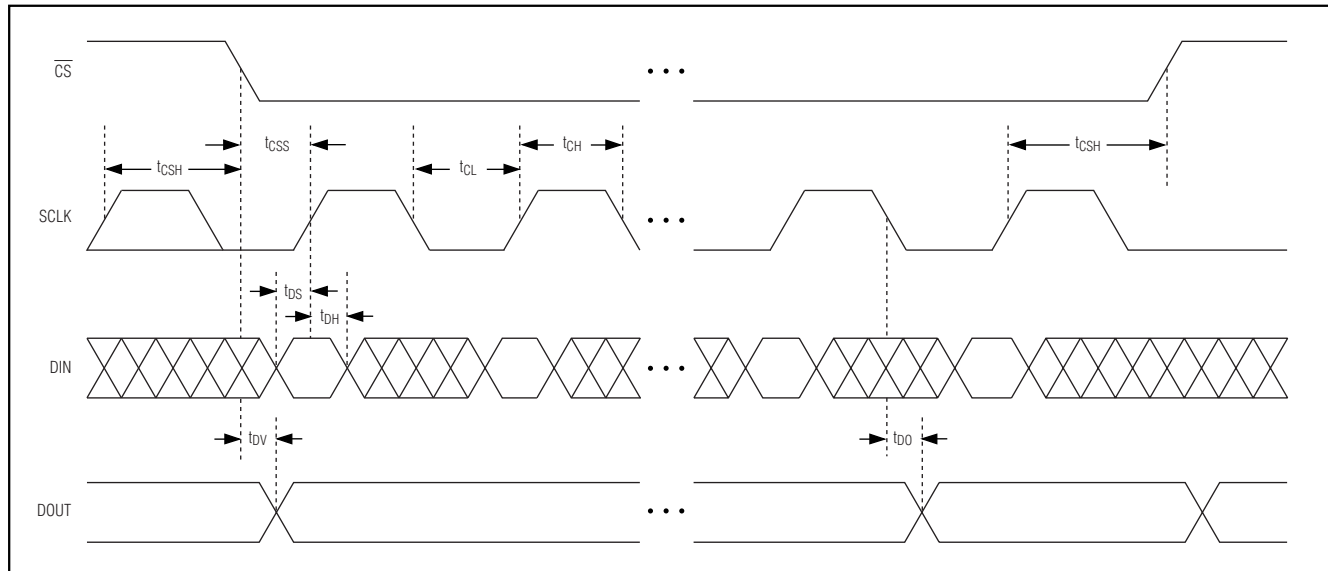

Figure 3. 4-Wire Interface Timing



# 4-Wire-Interfaced, 2.5V to 5.5V, 20-Port and 28-Port LED Display Driver and I/O Expander

MAX6957

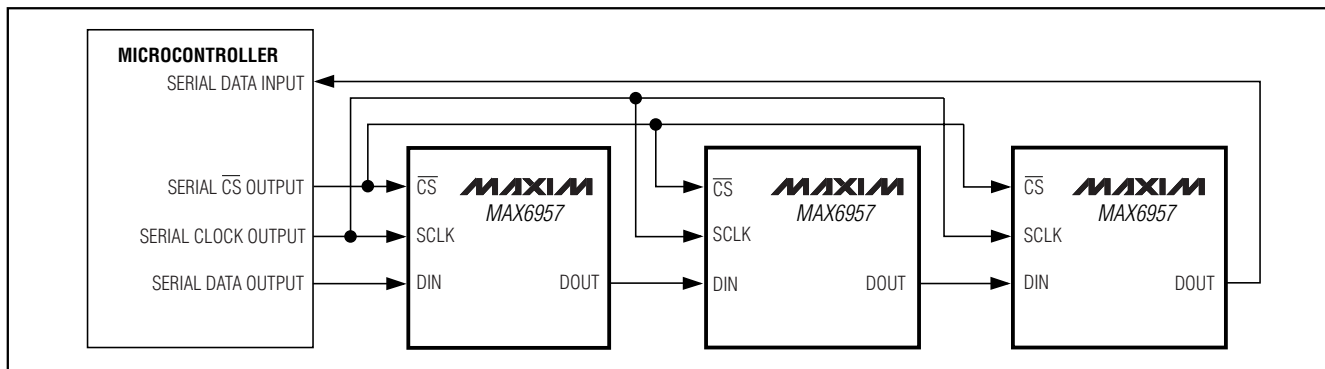

Figure 4. Daisy-Chain Arrangement for Controlling Multiple MAX6957s

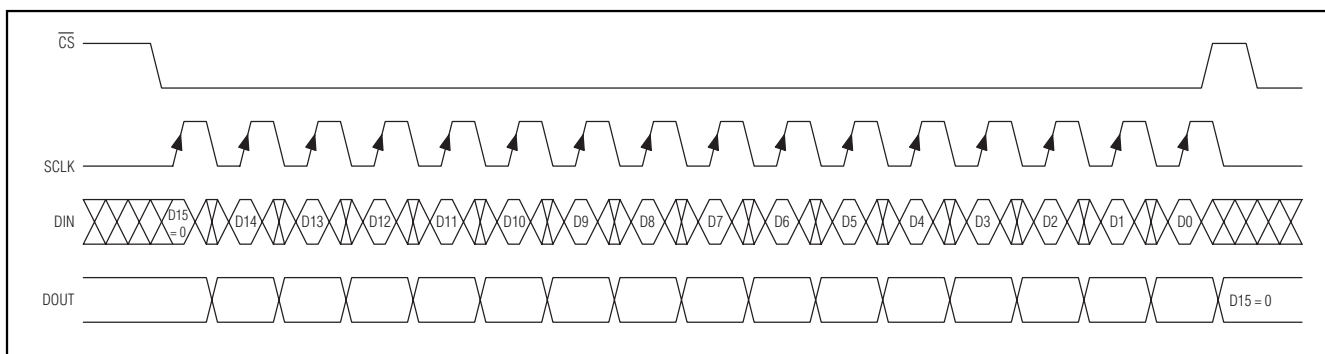

Figure 5. 16-Bit Write Transmission to the MAX6957

same time. An access requires  $(16 \times n)$  clock cycles, where  $n$  is the number of MAX6957s connected together. To update just one device in a daisy-chain, the user can send the No-Op command (0x00) to the others.

### Writing Device Registers

The MAX6957 contains a 16-bit shift register into which DIN data are clocked on the rising edge of SCLK, when  $\overline{CS}$  is low. When  $\overline{CS}$  is high, transitions on SCLK have no effect. When  $\overline{CS}$  goes high, the 16 bits in the Shift register are parallel loaded into a 16-bit latch. The 16 bits in the latch are then decoded and executed.

The MAX6957 is written to using the following sequence:

- 1) Take SCLK low.
- 2) Take  $\overline{CS}$  low. This enables the internal 16-bit shift register.
- 3) Clock 16 bits of data into DIN—D15 first, D0 last—observing the setup and hold times (bit D15 is low, indicating a write command).
- 4) Take  $\overline{CS}$  high (either while SCLK is still high after

clocking in the last data bit, or after taking SCLK low).

- 5) Take SCLK low (if not already low).

Figure 5 shows a write operation when 16 bits are transmitted.

It is acceptable to clock more than 16 bits into the MAX6957 between taking  $\overline{CS}$  low and taking  $\overline{CS}$  high again. In this case, only the last 16 bits clocked into the MAX6957 are retained.

### Reading Device Registers

Any register data within the MAX6957 may be read by sending a logic high to bit D15. The sequence is:

- 1) Take SCLK low.
- 2) Take  $\overline{CS}$  low (this enables the internal 16-bit shift register).
- 3) Clock 16 bits of data into DIN—D15 first to D0 last. D15 is high, indicating a read command and bits D14 through D8 containing the address of the register to be read. Bits D7–D0 contain dummy data, which is discarded.

## 4-Wire-Interfaced, 2.5V to 5.5V, 20-Port and 28-Port LED Display Driver and I/O Expander

- 4) Take  $\overline{CS}$  high (either while SCLK is still high after clocking in the last data bit, or after taking SCLK low), positions D7 through D0 in the Shift register are now loaded with the register data addressed by bits D1 through D8.
- 5) Take SCLK low (if not already low).
- 6) Issue another read or write command (which can be a No-Op), and examine the bit stream at DOUT; the second 8 bits are the contents of the register addressed by bits D1 through D8 in step 3.

### Initial Power-Up

On initial power-up, all control registers are reset, current registers are set to minimum value, and the MAX6957 enters shutdown mode (Table 4).

### LED Current Control

LED segment drive current can be set either globally or individually. Global control simplifies the operation when all LEDs are set to the same current level, because writing one register, the Global Current register, sets the current for all ports configured as LED segment drivers. It is also possible to individually control the current drive of each LED segment driver. Individual/global brightness control is selected by setting the configuration register I bit (Table 7). The global current register (0x02) data are then ignored, and segment currents are set using register addresses 0x12 through 0x1F (Tables 10, 11, and 12). Each segment is controlled by a nibble of one of the 16 current registers.

### Transition (Port Data Change) Detection

Port transition detection allows any combination of the seven ports P24–P30 to be continuously monitored for changes in their logic status (Figure 6). A detected change is flagged on port P31, which is used as an active-high interrupt output (INT). Note that the MAX6957 does not identify which specific port(s) caused the interrupt, but provides an alert that one or more port levels have changed.

The mask register contains 7 mask bits that select which of the seven ports P24–P30 are to be monitored (Table 13). Set the appropriate mask bit to enable that port for transition detect. Clear the mask bit if transitions on that port are to be ignored. Transition detection works regardless of whether the port being monitored is set to input or output, but generally it is not particularly useful to enable transition detection for outputs.

Port P31 must be configured as an output in order to work as the interrupt output INT when transition detection is used. Port P31 is set as output by writing bit D7

= 0 and bit D6 = 1 to the port configuration register (Table 1).

To use transition detection, first set up the mask register and configure port P31 as an output, as described above. Then enable transition detection by setting the M bit in the configuration register (Table 8). Whenever the configuration register is written with the M bit set, the MAX6957 updates an internal 7-bit snapshot register, which holds the comparison copy of the logic states of ports P24 through P30. The update action occurs regardless of the previous state of the M bit, so that it is not necessary to clear the M bit and then set it again to update the snapshot register.

When the configuration register is written with the M bit set, transition detection is enabled and remains enabled until either the configuration register is written with the M bit clear, or a transition is detected. The INT output port P31 goes low, if it was not already low.

Once transition detection is enabled, the MAX6957 continuously compares the snapshot register against the changing states of P24 through P31. If a change on any of the monitored ports is detected, even for a short time (like a pulse), INT output port P31 is latched high. The INT output is not cleared if more changes occur or if the data pattern returns to its original snapshot condition. The only way to clear INT is to access (read or write) the transition detection mask register (Table 13).

Transition detection is a one-shot event. When INT has been cleared after responding to a transition event, transition detection is automatically disabled, even though the M bit in the configuration register remains set (unless cleared by the user). Reenable transition detection by writing the configuration register with the M bit set to take a new snapshot of the seven ports, P24 to P30.

### Display Test Register

Display test mode turns on all ports configured as LED drivers by overriding, but not altering, all controls and port registers, except the port configuration register (Table 14). Only ports configured as LED drivers are affected. Ports configured as GPIO push-pull outputs do not change state. In display test mode, each port's current is temporarily set to 1/2 the maximum current limit as controlled by R<sub>ISSET</sub>.

### Selecting External Component R<sub>ISSET</sub> to Set Maximum Segment Current

The MAX6957 uses an external resistor R<sub>ISSET</sub> to set the maximum segment current. The recommended value, 39k $\Omega$ , sets the maximum current to 24mA, which makes

# 4-Wire-Interfaced, 2.5V to 5.5V, 20-Port and 28-Port LED Display Driver and I/O Expander

**MAX6957**

**Table 3. Register Address Map**

REGISTER	COMMAND ADDRESS								HEX CODE
	D15	D14	D13	D12	D11	D10	D9	D8	
No-Op	R/ $\overline{W}$	0	0	0	0	0	0	0	0x00
Global Current	R/ $\overline{W}$	0	0	0	0	0	1	0	0x02
Configuration	R/ $\overline{W}$	0	0	0	0	1	0	0	0x04
Transition Detect Mask	R/ $\overline{W}$	0	0	0	0	1	1	0	0x06
Display Test	R/ $\overline{W}$	0	0	0	0	1	1	1	0x07
Port Configuration P7, P6, P5, P4	R/ $\overline{W}$	0	0	0	1	0	0	1	0x09
Port Configuration P11, P10, P9, P8	R/ $\overline{W}$	0	0	0	1	0	1	0	0x0A
Port Configuration P15, P14, P13, P12	R/ $\overline{W}$	0	0	0	1	0	1	1	0x0B
Port Configuration P19, P18, P17, P16	R/ $\overline{W}$	0	0	0	1	1	0	0	0x0C
Port Configuration P23, P22, P21, P20	R/ $\overline{W}$	0	0	0	1	1	0	1	0x0D
Port Configuration P27, P26, P25, P24	R/ $\overline{W}$	0	0	0	1	1	1	0	0x0E
Port Configuration P31, P30, P29, P28	R/ $\overline{W}$	0	0	0	1	1	1	1	0x0F
Current054	R/ $\overline{W}$	0	0	1	0	0	1	0	0x12
Current076	R/ $\overline{W}$	0	0	1	0	0	1	1	0x13
Current098	R/ $\overline{W}$	0	0	1	0	1	0	0	0x14
Current0BA	R/ $\overline{W}$	0	0	1	0	1	0	1	0x15
Current0DC	R/ $\overline{W}$	0	0	1	0	1	1	0	0x16
Current0FE	R/ $\overline{W}$	0	0	1	0	1	1	1	0x17
Current110	R/ $\overline{W}$	0	0	1	1	0	0	0	0x18
Current132	R/ $\overline{W}$	0	0	1	1	0	0	1	0x19
Current154	R/ $\overline{W}$	0	0	1	1	0	1	0	0x1A
Current176	R/ $\overline{W}$	0	0	1	1	0	1	1	0x1B
Current198	R/ $\overline{W}$	0	0	1	1	1	0	0	0x1C
Current1BA	R/ $\overline{W}$	0	0	1	1	1	0	1	0x1D
Current1DC	R/ $\overline{W}$	0	0	1	1	1	1	0	0x1E
Current1FE	R/ $\overline{W}$	0	0	1	1	1	1	1	0x1F
Port 0 only (virtual port, no action)	R/ $\overline{W}$	0	1	0	0	0	0	0	0x20
Port 1 only (virtual port, no action)	R/ $\overline{W}$	0	1	0	0	0	0	1	0x21
Port 2 only (virtual port, no action)	R/ $\overline{W}$	0	1	0	0	0	1	0	0x22
Port 3 only (virtual port, no action)	R/ $\overline{W}$	0	1	0	0	0	1	1	0x23
Port 4 only (data bit D0. D7–D1 read as 0)	R/ $\overline{W}$	0	1	0	0	1	0	0	0x24
Port 5 only (data bit D0. D7–D1 read as 0)	R/ $\overline{W}$	0	1	0	0	1	0	1	0x25
Port 6 only (data bit D0. D7–D1 read as 0)	R/ $\overline{W}$	0	1	0	0	1	1	0	0x26
Port 7 only (data bit D0. D7–D1 read as 0)	R/ $\overline{W}$	0	1	0	0	1	1	1	0x27
Port 8 only (data bit D0. D7–D1 read as 0)	R/ $\overline{W}$	0	1	0	1	0	0	0	0x28
Port 9 only (data bit D0. D7–D1 read as 0)	R/ $\overline{W}$	0	1	0	1	0	0	1	0x29
Port 10 only (data bit D0. D7–D1 read as 0)	R/ $\overline{W}$	0	1	0	1	0	1	0	0x2A

# 4-Wire-Interfaced, 2.5V to 5.5V, 20-Port and 28-Port LED Display Driver and I/O Expander

**Table 3. Register Address Map (continued)**

REGISTER	COMMAND ADDRESS								HEX CODE
	D15	D14	D13	D12	D11	D10	D9	D8	
Port 11 only (data bit D0. D7–D1 read as 0)	R/ $\bar{W}$	0	1	0	1	0	1	1	0x2B
Port 12 only (data bit D0. D7–D1 read as 0)	R/ $\bar{W}$	0	1	0	1	1	0	0	0x2C
Port 13 only (data bit D0. D7–D1 read as 0)	R/ $\bar{W}$	0	1	0	1	1	0	1	0x2D
Port 14 only (data bit D0. D7–D1 read as 0)	R/ $\bar{W}$	0	1	0	1	1	1	0	0x2E
Port 15 only (data bit D0. D7–D1 read as 0)	R/ $\bar{W}$	0	1	0	1	1	1	1	0x2F
Port 16 only (data bit D0. D7–D1 read as 0)	R/ $\bar{W}$	0	1	1	0	0	0	0	0x30
Port 17 only (data bit D0. D7–D1 read as 0)	R/ $\bar{W}$	0	1	1	0	0	0	1	0x31
Port 18 only (data bit D0. D7–D1 read as 0)	R/ $\bar{W}$	0	1	1	0	0	1	0	0x32
Port 19 only (data bit D0. D7–D1 read as 0)	R/ $\bar{W}$	0	1	1	0	0	1	1	0x33
Port 20 only (data bit D0. D7–D1 read as 0)	R/ $\bar{W}$	0	1	1	0	1	0	0	0x34
Port 21 only (data bit D0. D7–D1 read as 0)	R/ $\bar{W}$	0	1	1	0	1	0	1	0x35
Port 22 only (data bit D0. D7–D1 read as 0)	R/ $\bar{W}$	0	1	1	0	1	1	0	0x36
Port 23 only (data bit D0. D7–D1 read as 0)	R/ $\bar{W}$	0	1	1	0	1	1	1	0x37
Port 24 only (data bit D0. D7–D1 read as 0)	R/ $\bar{W}$	0	1	1	1	0	0	0	0x38
Port 25 only (data bit D0. D7–D1 read as 0)	R/ $\bar{W}$	0	1	1	1	0	0	1	0x39
Port 26 only (data bit D0. D7–D1 read as 0)	R/ $\bar{W}$	0	1	1	1	0	1	0	0x3A
Port 27 only (data bit D0. D7–D1 read as 0)	R/ $\bar{W}$	0	1	1	1	0	1	1	0x3B
Port 28 only (data bit D0. D7–D1 read as 0)	R/ $\bar{W}$	0	1	1	1	1	0	0	0x3C
Port 29 only (data bit D0. D7–D1 read as 0)	R/ $\bar{W}$	0	1	1	1	1	0	1	0x3D
Port 30 only (data bit D0. D7–D1 read as 0)	R/ $\bar{W}$	0	1	1	1	1	1	0	0x3E
Port 31 only (data bit D0. D7–D1 read as 0)	R/ $\bar{W}$	0	1	1	1	1	1	1	0x3F
4 ports 4–7 (data bits D0–D3. D4–D7 read as 0)	R/ $\bar{W}$	1	0	0	0	0	0	0	0x40
5 ports 4–8 (data bits D0–D4. D5–D7 read as 0)	R/ $\bar{W}$	1	0	0	0	0	0	1	0x41
6 ports 4–9 (data bits D0–D5. D6–D7 read as 0)	R/ $\bar{W}$	1	0	0	0	0	1	0	0x42
7 ports 4–10 (data bits D0–D6. D7 reads as 0)	R/ $\bar{W}$	1	0	0	0	0	1	1	0x43
8 ports 4–11 (data bits D0–D7)	R/ $\bar{W}$	1	0	0	0	1	0	0	0x44
8 ports 5–12 (data bits D0–D7)	R/ $\bar{W}$	1	0	0	0	1	0	1	0x45
8 ports 6–13 (data bits D0–D7)	R/ $\bar{W}$	1	0	0	0	1	1	0	0x46
8 ports 7–14 (data bits D0–D7)	R/ $\bar{W}$	1	0	0	0	1	1	1	0x47
8 ports 8–15 (data bits D0–D7)	R/ $\bar{W}$	1	0	0	1	0	0	0	0x48
8 ports 9–16 (data bits D0–D7)	R/ $\bar{W}$	1	0	0	1	0	0	1	0x49
8 ports 10–17 (data bits D0–D7)	R/ $\bar{W}$	1	0	0	1	0	1	0	0x4A
8 ports 11–18 (data bits D0–D7)	R/ $\bar{W}$	1	0	0	1	0	1	1	0x4B
8 ports 12–19 (data bits D0–D7)	R/ $\bar{W}$	1	0	0	1	1	0	0	0x4C
8 ports 13–20 (data bits D0–D7)	R/ $\bar{W}$	1	0	0	1	1	0	1	0x4D
8 ports 14–21 (data bits D0–D7)	R/ $\bar{W}$	1	0	0	1	1	1	0	0x4E
8 ports 15–22 (data bits D0–D7)	R/ $\bar{W}$	1	0	0	1	1	1	1	0x4F

# 4-Wire-Interfaced, 2.5V to 5.5V, 20-Port and 28-Port LED Display Driver and I/O Expander

MAX6957

**Table 3. Register Address Map (continued)**

REGISTER	COMMAND ADDRESS								HEX CODE
	D15	D14	D13	D12	D11	D10	D9	D8	
8 ports 16–23 (data bits D0–D7)	R/ $\bar{W}$	1	0	1	0	0	0	0	0x50
8 ports 17–24 (data bits D0–D7)	R/ $\bar{W}$	1	0	1	0	0	0	1	0x51
8 ports 18–25 (data bits D0–D7)	R/ $\bar{W}$	1	0	1	0	0	1	0	0x52
8 ports 19–26 (data bits D0–D7)	R/ $\bar{W}$	1	0	1	0	0	1	1	0x53
8 ports 20–27 (data bits D0–D7)	R/ $\bar{W}$	1	0	1	0	1	0	0	0x54
8 ports 21–28 (data bits D0–D7)	R/ $\bar{W}$	1	0	1	0	1	0	1	0x55
8 ports 22–29 (data bits D0–D7)	R/ $\bar{W}$	1	0	1	0	1	1	0	0x56
8 ports 23–30 (data bits D0–D7)	R/ $\bar{W}$	1	0	1	0	1	1	1	0x57
8 ports 24–31 (data bits D0–D7)	R/ $\bar{W}$	1	0	1	1	0	0	0	0x58
7 ports 25–31 (data bits D0–D6. D7 reads as 0)	R/ $\bar{W}$	1	0	1	1	0	0	1	0x59
6 ports 26–31 (data bits D0–D5. D6, D7 read as 0)	R/ $\bar{W}$	1	0	1	1	0	1	0	0x5A
5 ports 27–31 (data bits D0–D4. D5–D7 read as 0)	R/ $\bar{W}$	1	0	1	1	0	1	1	0x5B
4 ports 28–31 (data bits D0–D3. D4–D7 read as 0)	R/ $\bar{W}$	1	0	1	1	1	0	0	0x5C
3 ports 29–31 (data bits D0–D2. D3–D7 read as 0)	R/ $\bar{W}$	1	0	1	1	1	0	1	0x5D
2 ports 30–31 (data bits D0–D1. D2–D7 read as 0)	R/ $\bar{W}$	1	0	1	1	1	1	0	0x5E
1 port 31 only (data bit D0. D1–D7 read as 0)	R/ $\bar{W}$	1	0	1	1	1	1	1	0x5F

**Note:** Unused bits read as 0.

the segment current adjustable from 1.5mA to 24mA in 1.5mA steps.

To set a different segment current, use the formula:

$$R_{ISET} = 936k\Omega / I_{SEG}$$

where  $I_{SEG}$  is the desired maximum segment current in mA.

The recommended value of  $R_{ISET}$  is 39k $\Omega$ .

The recommended value of  $R_{ISET}$  is the minimum allowed value, since it sets the display driver to the maximum allowed segment current.  $R_{ISET}$  can be a higher value to set the segment current to a lower maximum value where desired. The user must also ensure that the maximum current specifications of the LEDs connected to the driver are not exceeded.

The drive current for each segment can be controlled through programming either the global current register (Table 9) or individual segment current registers (Tables 10, 11, and 12), according to the setting of the current control bit of the configuration register (Table 7). These registers select the LED's constant-current drive from 16 equal fractions of the maximum segment current. The current difference between successive cur-

rent steps,  $I_{STEP}$ , is therefore determined by the formula:

$$I_{STEP} = I_{SEG} / 16$$

If  $I_{SEG} = 24\text{mA}$ , then  $I_{STEP} = 24\text{mA} / 16 = 1.5\text{mA}$ .

## Applications Information

### Driving Bicolor and Tricolor LEDs

Bicolor digits group a red and a green die together for each display element, so that the element can be lit red, green (or orange), depending on which die (or both) is lit. The MAX6957 allows each segment's current to be set individually from 1/16th (minimum current and LED intensity) to 16/16th (maximum current and LED intensity), as well as off (zero current). Thus, a bicolor (red-green) segment pair can be set to 289 color/intensity combinations. A discrete or CA tricolor (red-green-yellow or red-green-blue) segment triad can be set to 4913 color/intensity combinations.

### Power Dissipation Issues

Each MAX6957 port can sink a current of 24mA into an LED with a 2.4V forward-voltage drop when operated from a supply voltage of at least 3.0V. The minimum

# 4-Wire-Interfaced, 2.5V to 5.5V, 20-Port and 28-Port LED Display Driver and I/O Expander

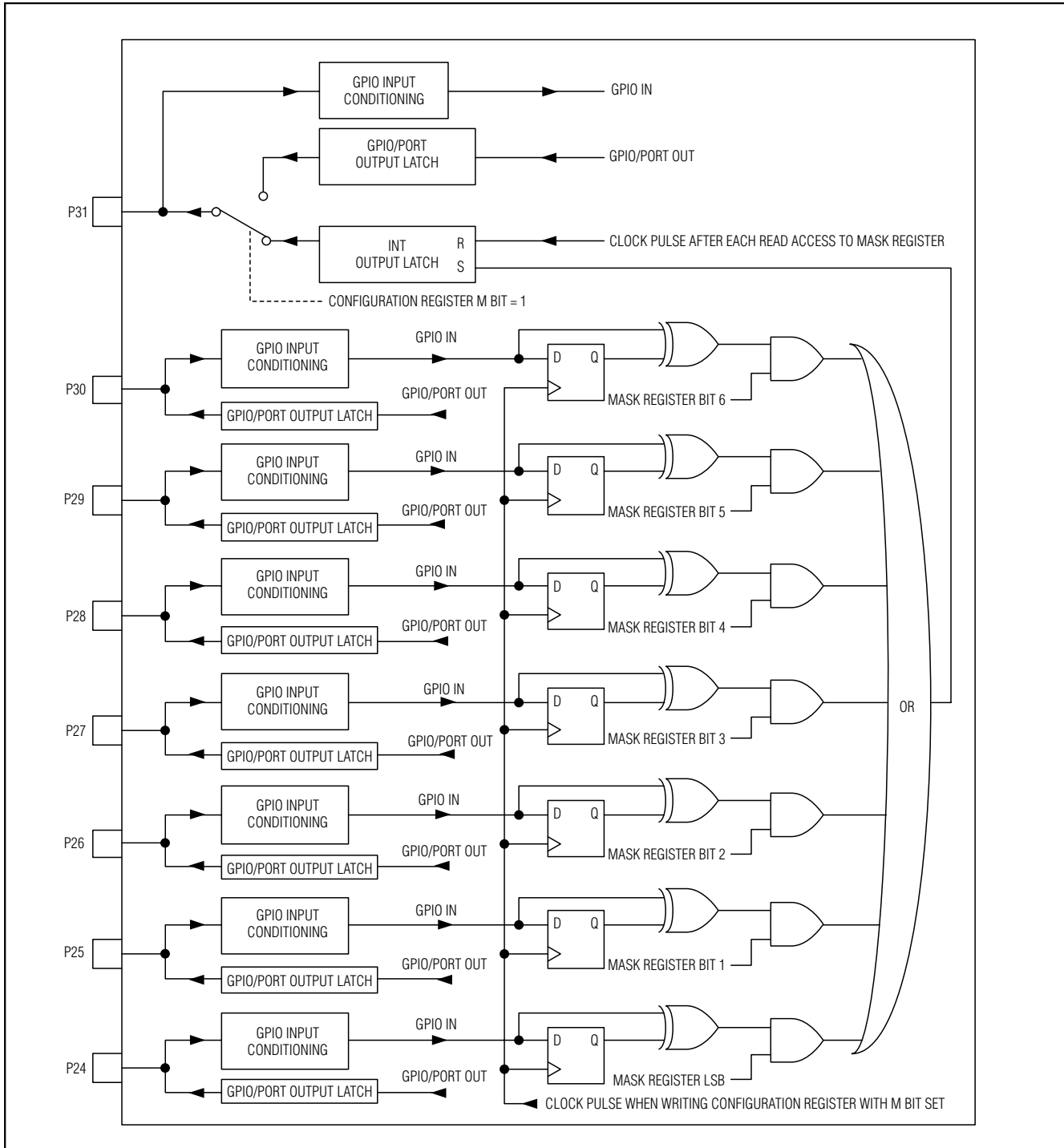

Figure 6. Maskable GPIO Ports P24 Through P31

# 4-Wire-Interfaced, 2.5V to 5.5V, 20-Port and 28-Port LED Display Driver and I/O Expander

**MAX6957**

**Table 4. Power-Up Configuration**

REGISTER FUNCTION	POWER-UP CONDITION	ADDRESS CODE (HEX)	REGISTER DATA							
			D7	D6	D5	D4	D3	D2	D1	D0
Port Register Bits 4 to 31	LED Off; GPIO Output Low	0x24 to 0x3F	X	X	X	X	X	X	X	0
Global Current	1/16 (minimum on)	0x02	X	X	X	X	0	0	0	0
Configuration Register	Shutdown Enabled Current Control = Global Transition Detection Disabled	0x04	0	0	X	X	X	X	X	0
Input Mask Register	All Clear (Masked Off)	0x06	X	0	0	0	0	0	0	0
Display Test	Normal Operation	0x07	X	X	X	X	X	X	X	0
Port Configuration	P7, P6, P5, P4: GPIO Inputs Without Pullup	0x09	1	0	1	0	1	0	1	0
Port Configuration	P11, P10, P9, P8: GPIO Inputs Without Pullup	0x0A	1	0	1	0	1	0	1	0
Port Configuration	P15, P14, P13, P12: GPIO Inputs Without Pullup	0x0B	1	0	1	0	1	0	1	0
Port Configuration	P19, P18, P17, P16: GPIO Inputs Without Pullup	0x0C	1	0	1	0	1	0	1	0
Port Configuration	P23, P22, P21, P20: GPIO Inputs Without Pullup	0x0D	1	0	1	0	1	0	1	0
Port Configuration	P27, P26, P25, P24: GPIO Inputs Without Pullup	0x0E	1	0	1	0	1	0	1	0
Port Configuration	P31, P30, P29, P28: GPIO Inputs Without Pullup	0x0F	1	0	1	0	1	0	1	0
Current054	1/16 (minimum on)	0x12	0	0	0	0	0	0	0	0
Current076	1/16 (minimum on)	0x13	0	0	0	0	0	0	0	0
Current098	1/16 (minimum on)	0x14	0	0	0	0	0	0	0	0
Current0BA	1/16 (minimum on)	0x15	0	0	0	0	0	0	0	0
Current0DC	1/16 (minimum on)	0x16	0	0	0	0	0	0	0	0
Current0FE	1/16 (minimum on)	0x17	0	0	0	0	0	0	0	0
Current110	1/16 (minimum on)	0x18	0	0	0	0	0	0	0	0
Current132	1/16 (minimum on)	0x19	0	0	0	0	0	0	0	0
Current154	1/16 (minimum on)	0x1A	0	0	0	0	0	0	0	0
Current176	1/16 (minimum on)	0x1B	0	0	0	0	0	0	0	0
Current198	1/16 (minimum on)	0x1C	0	0	0	0	0	0	0	0
Current1BA	1/16 (minimum on)	0x1D	0	0	0	0	0	0	0	0
Current1DC	1/16 (minimum on)	0x1E	0	0	0	0	0	0	0	0
Current1FE	1/16 (minimum on)	0x1F	0	0	0	0	0	0	0	0

X = unused bits; if read, zero results.

# 4-Wire-Interfaced, 2.5V to 5.5V, 20-Port and 28-Port LED Display Driver and I/O Expander

**Table 5. Configuration Register Format**

FUNCTION	ADDRESS CODE (HEX)	REGISTER DATA							
		D7	D6	D5	D4	D3	D2	D1	D0
Configuration Register	0x04	M	I	X	X	X	X	X	S

X = Don't care bit.

**Table 6. Shutdown Control (S Data Bit D0) Format**

FUNCTION	ADDRESS CODE (HEX)	REGISTER DATA							
		D7	D6	D5	D4	D3	D2	D1	D0
Shutdown	0x04	M	I	X	X	X	X	X	0
Normal Operation	0x04	M	I	X	X	X	X	X	1

X = Don't care bit.

**Table 7. Global Current Control (I Data Bit D6) Format**

FUNCTION	ADDRESS CODE (HEX)	REGISTER DATA							
		D7	D6	D5	D4	D3	D2	D1	D0
Global Constant-current limits for all digits are controlled by one setting in the Global Current register, 0x02	0x04	M	0	X	X	X	X	X	S
Individual Segment Constant-current limit for each digit is individually controlled by the settings in the Current054 through Current1FE registers	0x04	M	1	X	X	X	X	X	S

X = Don't care bit.

**Table 8. Transition Detection Control (M-Data Bit D7) Format**

FUNCTION	ADDRESS CODE (HEX)	REGISTER DATA							
		D7	D6	D5	D4	D3	D2	D1	D0
Disabled	0x04	0	I	X	X	X	X	X	S
Enabled	0x04	1	I	X	X	X	X	X	S

X = Don't care bit.

**Table 9. Global Segment Current Register Format**

LED DRIVE FRACTION	TYPICAL SEGMENT CURRENT (mA)	ADDRESS CODE (HEX)	D7	D6	D5	D4	D3	D2	D1	D0	HEX CODE
1/16	1.5	0x02	X	X	X	X	0	0	0	0	0xX0
2/16	3	0x02	X	X	X	X	0	0	0	1	0xX1
3/16	4.5	0x02	X	X	X	X	0	0	1	0	0xX2
4/16	6	0x02	X	X	X	X	0	0	1	1	0xX3
5/16	7.5	0x02	X	X	X	X	0	1	0	0	0xX4

X = Don't care bit.



# 4-Wire-Interfaced, 2.5V to 5.5V, 20-Port and 28-Port LED Display Driver and I/O Expander

MAX6957

**Table 9. Global Segment Current Register Format (continued)**

LED DRIVE FRACTION	TYPICAL SEGMENT CURRENT (mA)	ADDRESS CODE (HEX)	D7	D6	D5	D4	D3	D2	D1	D0	HEX CODE
6/16	9	0x02	X	X	X	X	0	1	0	1	0xX5
7/16	10.5	0x02	X	X	X	X	0	1	1	0	0xX6
8/16	12	0x02	X	X	X	X	0	1	1	1	0xX7
9/16	13.5	0x02	X	X	X	X	1	0	0	0	0xX8
10/16	15	0x02	X	X	X	X	1	0	0	1	0xX9
11/16	16.5	0x02	X	X	X	X	1	0	1	0	0xXA
12/16	18	0x02	X	X	X	X	1	0	1	1	0xXB
13/16	19.5	0x02	X	X	X	X	1	1	0	0	0xXC
14/16	21	0x02	X	X	X	X	1	1	0	1	0xXD
15/16	22.5	0x02	X	X	X	X	1	1	1	0	0xXE
16/16	24	0x02	X	X	X	X	1	1	1	1	0xFF

X = Don't care bit.

**Table 10. Individual Segment Current Registers**

REGISTER FUNCTION	ADDRESS CODE (HEX)	D7	D6	D5	D4	D3	D2	D1	D0
Current054 register	0x12	Segment 5				Segment 4			
Current076 register	0x13	Segment 7				Segment 6			
Current098 register	0x14	Segment 9				Segment 8			
Current0BA register	0x15	Segment 11				Segment 10			
Current0DC register	0x16	Segment 13				Segment 12			
Current0FE register	0x17	Segment 15				Segment 14			
Current110 register	0x18	Segment 17				Segment 16			
Current132 register	0x19	Segment 19				Segment 18			
Current154 register	0x1A	Segment 21				Segment 20			
Current176 register	0x1B	Segment 23				Segment 22			
Current198 register	0x1C	Segment 25				Segment 24			
Current1BA register	0x1D	Segment 27				Segment 26			
Current1DC register	0x1E	Segment 29				Segment 28			
Current1FE register	0x1F	Segment 31				Segment 30			

# 4-Wire-Interfaced, 2.5V to 5.5V, 20-Port and 28-Port LED Display Driver and I/O Expander

Table 11. Even Individual Segment Current Format

LED DRIVE FRACTION	SEGMENT CONSTANT CURRENT WITH $R_{ISET} = 39k\Omega$ (mA)	ADDRESS CODE (HEX)	D7	D6	D5	D4	D3	D2	D1	D0	HEX CODE
1/16	1.5	0x12 to 0x1F	See Table 12.				0	0	0	0	0xX0
2/16	3	0x12 to 0x1F					0	0	0	1	0xX1
3/16	4.5	0x12 to 0x1F					0	0	1	0	0xX2
4/16	6	0x12 to 0x1F					0	0	1	1	0xX3
5/16	7.5	0x12 to 0x1F					0	1	0	0	0xX4
6/16	9	0x12 to 0x1F					0	1	0	1	0xX5
7/16	10.5	0x12 to 0x1F					0	1	1	0	0xX6
8/16	12	0x12 to 0x1F					0	1	1	1	0xX7
9/16	13.5	0x12 to 0x1F					1	0	0	0	0xX8
10/16	15	0x12 to 0x1F					1	0	0	1	0xX9
11/16	16.5	0x12 to 0x1F					1	0	1	0	0xXA
12/16	18	0x12 to 0x1F					1	0	1	1	0xXB
13/16	19.5	0x12 to 0x1F					1	1	0	0	0xXC
14/16	21	0x12 to 0x1F					1	1	0	1	0xDD
15/16	22.5	0x12 to 0x1F					1	1	1	0	0xXE
16/16	24	0x12 to 0x1F					1	1	1	1	0xFF

voltage drop across the internal LED drivers is therefore  $(3.0V - 2.4V) = 0.6V$ . The MAX6957 can sink  $28 \times 24mA = 672mA$  when all outputs are operating as LED segment drivers at full current. On a 3.3V supply, a MAX6957 dissipates  $(3.3V - 2.4V) \times 672mA = 0.6W$  when driving 28 of these 2.4V forward-voltage drop LEDs at full current. This dissipation is within the ratings of the 36-pin SSOP package with an ambient temperature up to  $+98^{\circ}C$ . If a higher supply voltage is used or the LEDs used have a lower forward-voltage drop than 2.4V, the MAX6957 absorbs a higher voltage, and the MAX6957's power dissipation increases.

If the application requires high drive current and high supply voltage, consider adding a series resistor to each LED to drop excessive drive voltage off-chip. For example, consider the requirement that the MAX6957 must drive LEDs with a 2.0V to 2.4V specified forward-voltage drop, from an input supply range is  $5V \pm 5\%$  with a maximum LED current of 20mA. Minimum input supply voltage is 4.75V. Maximum LED series resistor value is  $(4.75V - 2.4V - 0.6V)/0.020A = 87.5\Omega$ . We choose  $82\Omega \pm 2\%$ . Worst-case resistor dissipation is at maximum toleranced resistance, i.e.,  $(0.020A)^2 \times (82\Omega \times 1.02) = 34mW$ . The maximum MAX6957 dissipation per LED is at maximum input supply voltage, minimum toleranced resistance, minimum toleranced LED for-

ward-voltage drop, i.e.,  $0.020 \times (5.25V - 2.0V - (0.020A \times 82\Omega \times 0.98)) = 32.86mW$ . Worst-case MAX6957 dissipation is 920mW, driving all 28 LEDs at 20mA full current at once, which meets the 941mW dissipation ratings of the 36-pin SSOP package.

### Low-Voltage Operation

The MAX6957 operates down to 2V supply voltage (although the sourcing and sinking currents are not guaranteed), providing that the MAX6957 is powered up initially to at least 2.5V to trigger the device's internal reset, and also that the serial interface is constrained to 10Mbps.

### SPI Routing Considerations

The MAX6957's SPI interface is guaranteed to operate at 26Mbps on a 2.5V supply, and on a 5V supply typically operates at 50Mbps. This means that the transmission line issues should be considered when the interface connections are longer than 100mm, particularly with higher supply voltages. Ringing manifests itself as communication issues, often intermittent, typically due to double clocking due to ringing at the SCLK input. Fit a  $1k\Omega$  to  $10k\Omega$  parallel termination resistor to either GND or V+ at the DIN, SCLK, and  $\overline{CS}$  input to damp ringing for moderately long interface runs. Use line impedance matching terminations when making connections between boards.

# 4-Wire-Interfaced, 2.5V to 5.5V, 20-Port and 28-Port LED Display Driver and I/O Expander

MAX6957

## PC Board Layout Considerations

Ensure that all the MAX6957 GND connections are used. A ground plane is not necessary, but may be useful to reduce supply impedance if the MAX6957 out-

puts are to be heavily loaded. Keep the track length from the ISET pin to the R<sub>ISET</sub> resistor as short as possible, and take the GND end of the resistor either to the ground plane or directly to the GND pins.

**Table 12. Odd Individual Segment Current Format**

LED DRIVE FRACTION	SEGMENT CONSTANT CURRENT WITH R <sub>ISET</sub> = 39kΩ (mA)	ADDRESS CODE (HEX)	D7	D6	D5	D4	D3	D2	D1	D0	HEX CODE
1/16	1.5	0x12 to 0x1F	0	0	0	0	See Table 11.				0x0X
2/16	3	0x12 to 0x1F	0	0	0	1					0x1X
3/16	4.5	0x12 to 0x1F	0	0	1	0					0x2X
4/16	6	0x12 to 0x1F	0	0	1	1					0x3X
5/16	7.5	0x12 to 0x1F	0	1	0	0					0x4X
6/16	9	0x12 to 0x1F	0	1	0	1					0x5X
7/16	10.5	0x12 to 0x1F	0	1	1	0					0x6X
8/16	12	0x12 to 0x1F	0	1	1	1					0x7X
9/16	13.5	0x12 to 0x1F	1	0	0	0					0x8X
10/16	15	0x12 to 0x1F	1	0	0	1					0x9X
11/16	16.5	0x12 to 0x1F	1	0	1	0					0xAx
12/16	18	0x12 to 0x1F	1	0	1	1					0xBx
13/16	19.5	0x12 to 0x1F	1	1	0	0					0xCx
14/16	21	0x12 to 0x1F	1	1	0	1					0xDx
15/16	22.5	0x12 to 0x1F	1	1	1	0					0xEx
16/16	24	0x12 to 0x1F	1	1	1	1					0xFx

**Table 13. Transition Detection Mask Register**

FUNCTION	REGISTER ADDRESS (HEX)	READ/ WRITE	REGISTER DATA							
			D7	D6	D5	D4	D3	D2	D1	D0
Mask Register	0x06	Read	0	Port 30 mask	Port 29 mask	Port 28 mask	Port 27 mask	Port 26 mask	Port 25 mask	Port 24 mask
		Write	Unchanged							

X = Don't care bit.

MODE	ADDRESS CODE (HEX)	REGISTER DATA							
		D7	D6	D5	D4	D3	D2	D1	D0
Normal Operation	0x07	X	X	X	X	X	X	X	0
Display Test Mode	0x07	X	X	X	X	X	X	X	1

# 4-Wire-Interfaced, 2.5V to 5.5V, 20-Port and 28-Port LED Display Driver and I/O Expander

## Power-Supply Considerations

The MAX6957 operates with power-supply voltages of 2.5V to 5.5V. Bypass the power supply to GND with a 0.047µF capacitor as close to the device as possible. Add a 1µF capacitor if the MAX6957 is far away from the board's input bulk decoupling capacitor.

## Chip Information

TRANSISTOR COUNT: 30,316

PROCESS: CMOS

## Pin Configurations (continued)

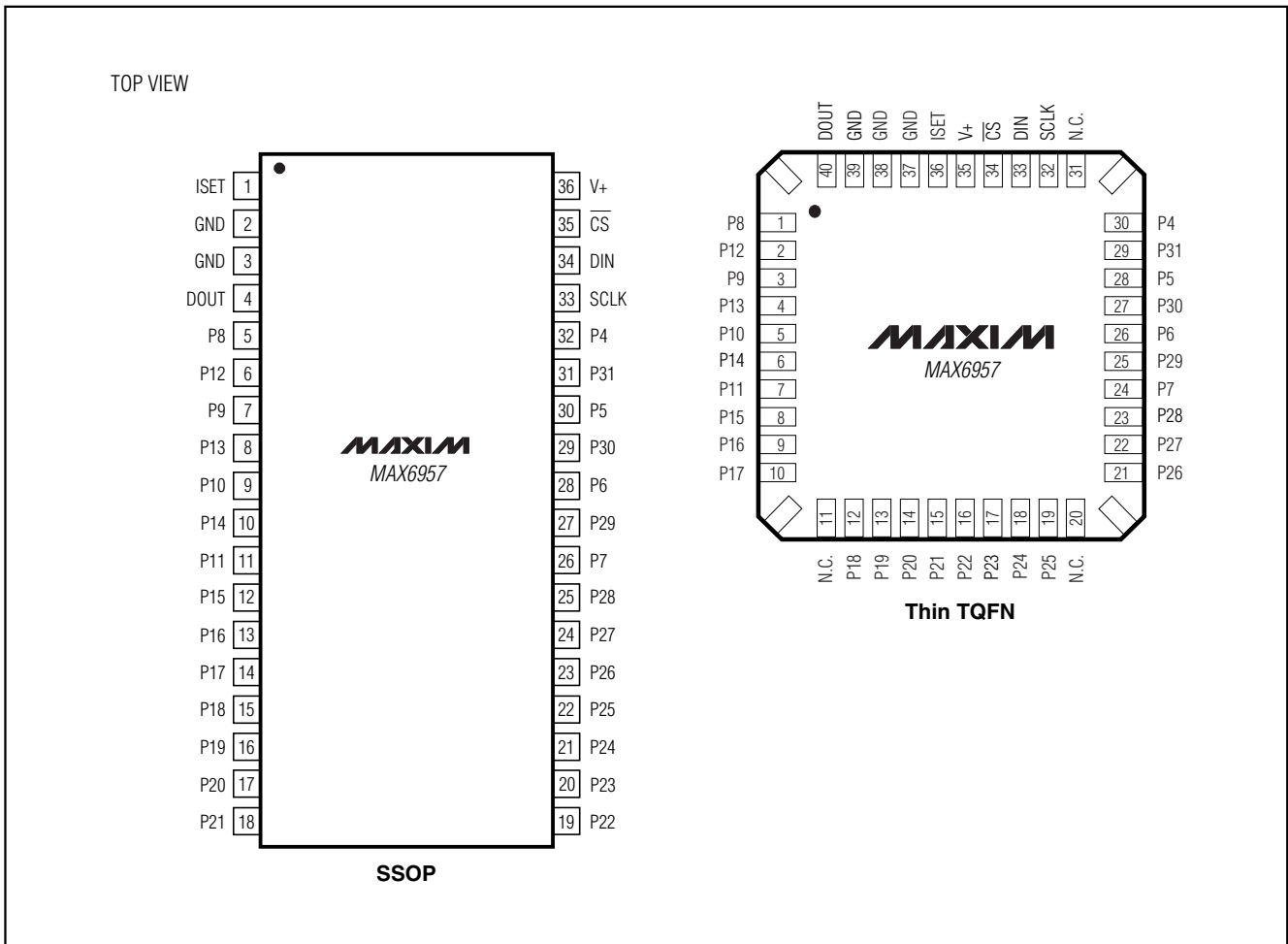

# 4-Wire-Interfaced, 2.5V to 5.5V, 20-Port and 28-Port LED Display Driver and I/O Expander

## Typical Operating Circuit

MAX6957

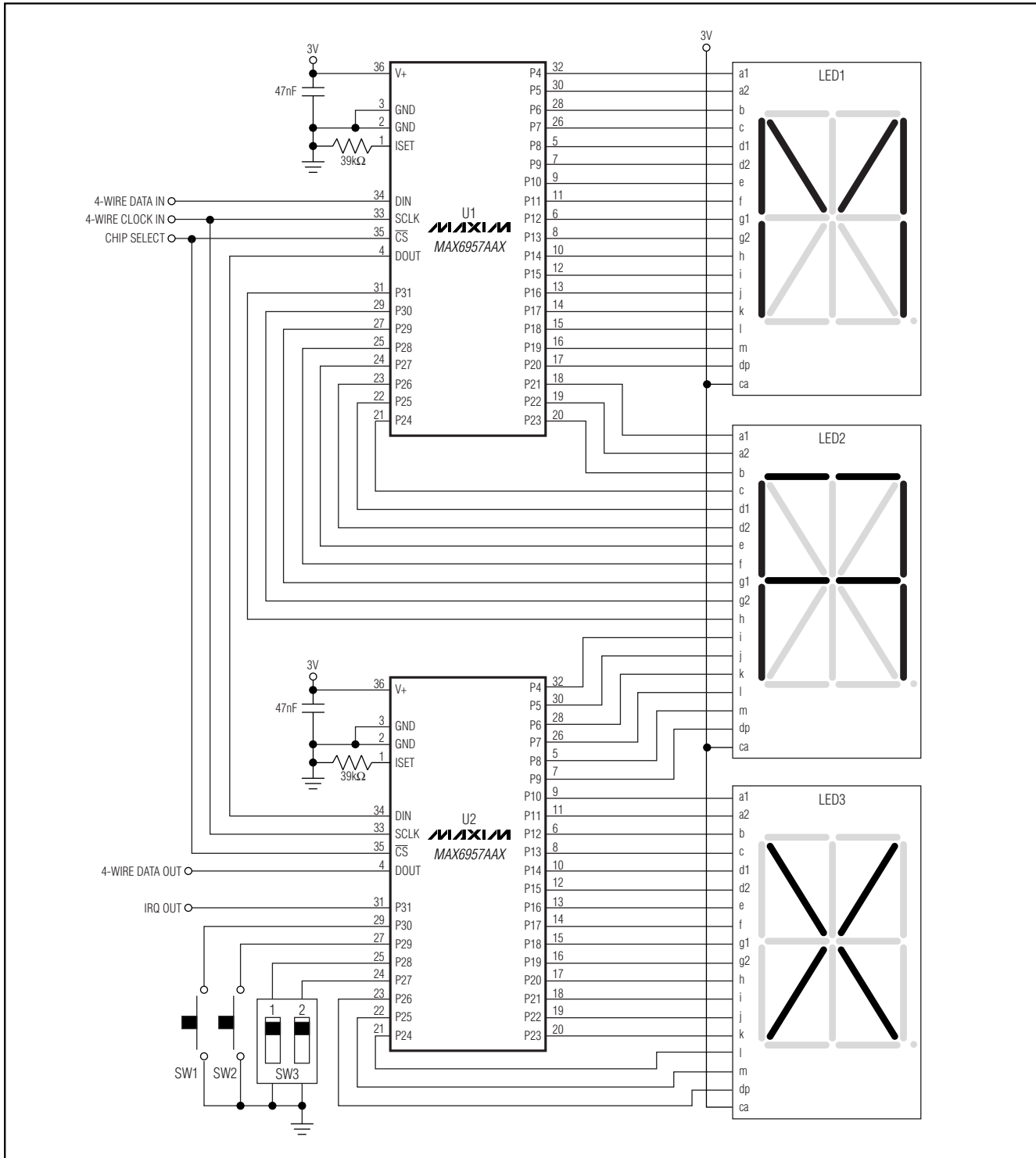

# 4-Wire-Interfaced, 2.5V to 5.5V, 20-Port and 28-Port LED Display Driver and I/O Expander

## Package Information

(The package drawing(s) in this data sheet may not reflect the most current specifications. For the latest package outline information, go to [www.maxim-ic.com/packages](http://www.maxim-ic.com/packages).)

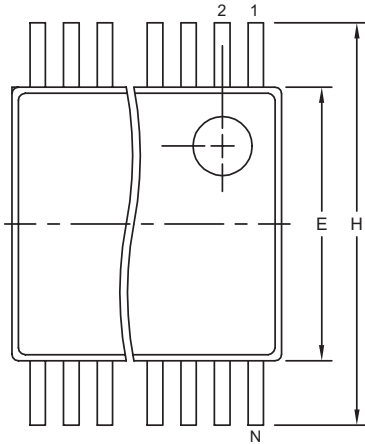

DIM	INCHES		MILLIMETERS	
	MIN	MAX	MIN	MAX
A	0.068	0.078	1.73	1.99
A1	0.002	0.008	0.05	0.21
B	0.010	0.015	0.25	0.38
C	0.004	0.008	0.09	0.20
D	SEE VARIATIONS			
E	0.205	0.212	5.20	5.38
e	0.0256 BSC		0.65 BSC	
H	0.301	0.311	7.65	7.90
L	0.025	0.037	0.63	0.95
$\alpha$	0	8	0	8

D	INCHES		MILLIMETERS		N
	MIN	MAX	MIN	MAX	
D	0.239	0.249	6.07	6.33	14L
D	0.239	0.249	6.07	6.33	16L
D	0.278	0.289	7.07	7.33	20L
D	0.317	0.328	8.07	8.33	24L
D	0.397	0.407	10.07	10.33	28L

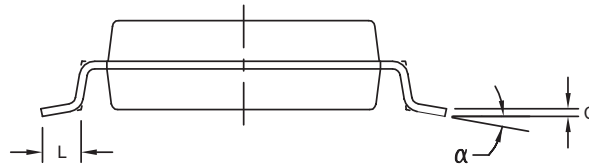
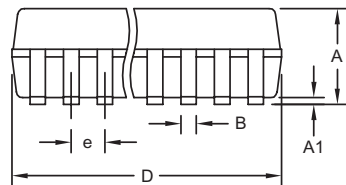

NOTES:

1. D&E DO NOT INCLUDE MOLD FLASH.
2. MOLD FLASH OR PROTRUSIONS NOT TO EXCEED .15 MM (.006").
3. CONTROLLING DIMENSION: MILLIMETERS.
4. MEETS JEDEC MO150.
5. LEADS TO BE COPLANAR WITHIN 0.10 MM.

<small>PROPRIETARY INFORMATION</small>	
<small>TITLE:</small> PACKAGE OUTLINE, SSOP, 5.3 MM	
<small>APPROVAL</small>	<small>DOCUMENT CONTROL NO.</small> 21-0056
<small>REV.</small> C	<small>1/1</small>

SSOP:EPS

# 4-Wire-Interfaced, 2.5V to 5.5V, 20-Port and 28-Port LED Display Driver and I/O Expander

## Package Information (continued)

(The package drawing(s) in this data sheet may not reflect the most current specifications. For the latest package outline information, go to [www.maxim-ic.com/packages](http://www.maxim-ic.com/packages).)

**MAX6957**

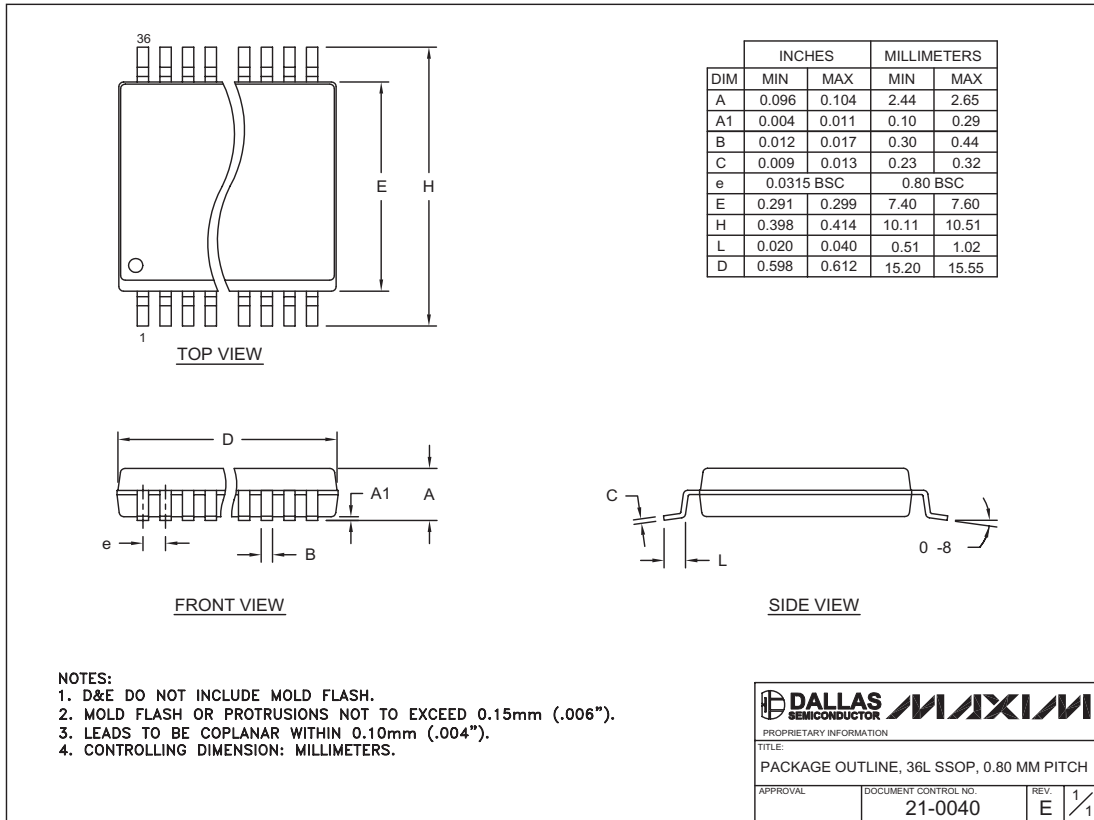

# 4-Wire-Interfaced, 2.5V to 5.5V, 20-Port and 28-Port LED Display Driver and I/O Expander

## Package Information (continued)

(The package drawing(s) in this data sheet may not reflect the most current specifications. For the latest package outline information, go to [www.maxim-ic.com/packages](http://www.maxim-ic.com/packages).)

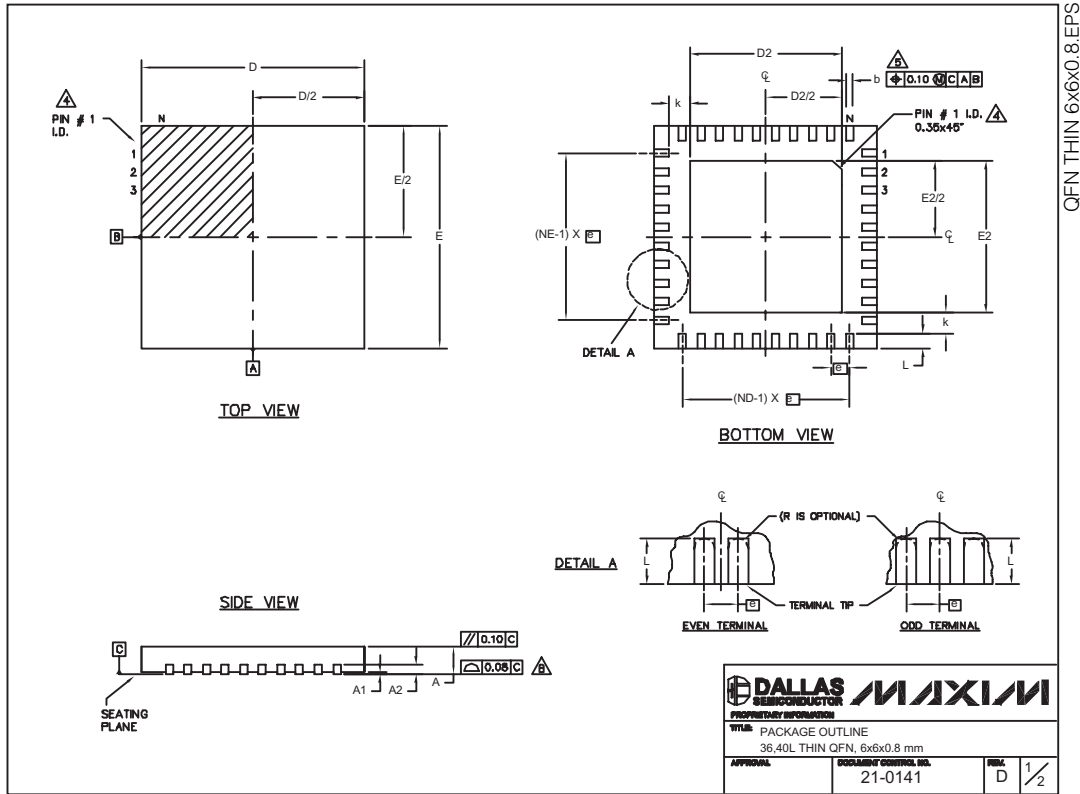



# 4-Wire-Interfaced, 2.5V to 5.5V, 20-Port and 28-Port LED Display Driver and I/O Expander

## Package Information (continued)

(The package drawing(s) in this data sheet may not reflect the most current specifications. For the latest package outline information, go to [www.maxim-ic.com/packages](http://www.maxim-ic.com/packages).)

MAX6957

COMMON DIMENSIONS						
PKG. SYMBOL	36L 6x6			40L 6x6		
	MIN.	NOM.	MAX.	MIN.	NOM.	MAX.
A	0.70	0.75	0.80	0.70	0.75	0.80
A1	0	0.02	0.05	0	0.02	0.05
A2	0.20 REF.			0.20 REF.		
b	0.20	0.25	0.30	0.20	0.25	0.30
D	5.90	6.00	6.10	5.90	6.00	6.10
E	5.90	6.00	6.10	5.90	6.00	6.10
e	0.50 BSC.			0.50 BSC.		
k	0.25	-	-	0.25	-	-
L	0.45	0.55	0.65	0.30	0.40	0.50
N	36			40		
ND	9			10		
NE	9			10		
JEDEC	WJJD-1			WJJD-2		

EXPOSED PAD VARIATIONS						
PKG. CODES	D2			E2		
	MIN.	NOM.	MAX.	MIN.	NOM.	MAX.
T3666-1	3.60	3.70	3.80	3.60	3.70	3.80
T4066-1	4.00	4.10	4.20	4.00	4.10	4.20
T4066-2	4.00	4.10	4.20	4.00	4.10	4.20

### NOTES:

- DIMENSIONING & TOLERANCING CONFORM TO ASME Y14.5M-1994.
- ALL DIMENSIONS ARE IN MILLIMETERS. ANGLES ARE IN DEGREES.
- N IS THE TOTAL NUMBER OF TERMINALS.
- △ THE TERMINAL #1 IDENTIFIER AND TERMINAL NUMBERING CONVENTION SHALL CONFORM TO JESD 95-1 SPP-012. DETAILS OF TERMINAL #1 IDENTIFIER ARE OPTIONAL, BUT MUST BE LOCATED WITHIN THE ZONE INDICATED. THE TERMINAL #1 IDENTIFIER MAY BE EITHER A MOLD OR MARKED FEATURE.
- △ DIMENSION b APPLIES TO METALLIZED TERMINAL AND IS MEASURED BETWEEN 0.25 mm AND 0.30 mm FROM TERMINAL TIP.
- ND AND NE REFER TO THE NUMBER OF TERMINALS ON EACH D AND E SIDE RESPECTIVELY.
- DEPOPULATION IS POSSIBLE IN A SYMMETRICAL FASHION.
- △ COPLANARITY APPLIES TO THE EXPOSED HEAT SINK SLUG AS WELL AS THE TERMINALS.
- DRAWING CONFORMS TO JEDEC MO220.
- WARPAGE SHALL NOT EXCEED 0.10 mm.

	
<small>PROPRIETARY INFORMATION</small>	
<small>TITLE</small> PACKAGE OUTLINE <small>36, 40L THIN QFN, 6x6x0.8 mm</small>	
<small>APPROVAL</small>	<small>DOCUMENT CONTROL NO.</small> 21-0141
<small>FILE</small> D	<small>REV</small> 2/2

Maxim cannot assume responsibility for use of any circuitry other than circuitry entirely embodied in a Maxim product. No circuit patent licenses are implied. Maxim reserves the right to change the circuitry and specifications without notice at any time.

**Maxim Integrated Products, 120 San Gabriel Drive, Sunnyvale, CA 94086 408-737-7600** \_\_\_\_\_ 25